



WE MAGNETISE THE WORLD



Frame solenoids

Single-Stroke Solenoids for Industrial Applications



INDUSTRIAL MAGNETIC SYSTEMS



Direct acting solenoid LCL-D

The **D-Frame Solenoids** of the type series **LCL** meet high standards in terms of performance and life expectancy.

Compact dimensions and low power consumption, fast switching times and smooth operation characterise this series. The housing is made of precision steel tube. The armature is guided in highly wear-resistant maintenance-free precision bearings on both sides, resulting in consistent solenoid performance throughout the long service life.

Parts at risk of corrosion are electro-galvanized.

The armature is chemically nickel-plated.

Either lateral or front mounting via threaded holes is possible.

Accessories

- Fork head (Page 23)
- Plug-in connector (Page 22)
- Optimization of control by micro power controllers on request

Model

- Connection by connector plug-Protection class IP65
- Lead wires - Protection class IP00
- Standard rated voltage = 24 V DC / 205 V DC
- Standard duty cycle = 100% ED

LCL-D Standard

The coil is supplied **encapsulated with plastics** as standard.

Accessories: Return spring can be used (Page 21)

Model: Device - Protection class IP40
Insulation class „B“ - 130°C

Excels by

Compact design

Pushing & pulling application

Maintenance-free use

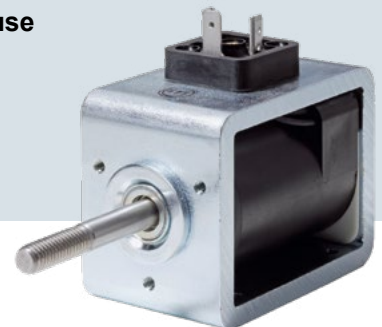

LCL-D with bellow

The coil is supplied **encapsulated** as standard

Accessories: Return spring **can not** be used

Model: Device - Protection class IP54
Insulation class „B“ - 130°C

Excels by

Higher protection class



LCL-D Standard

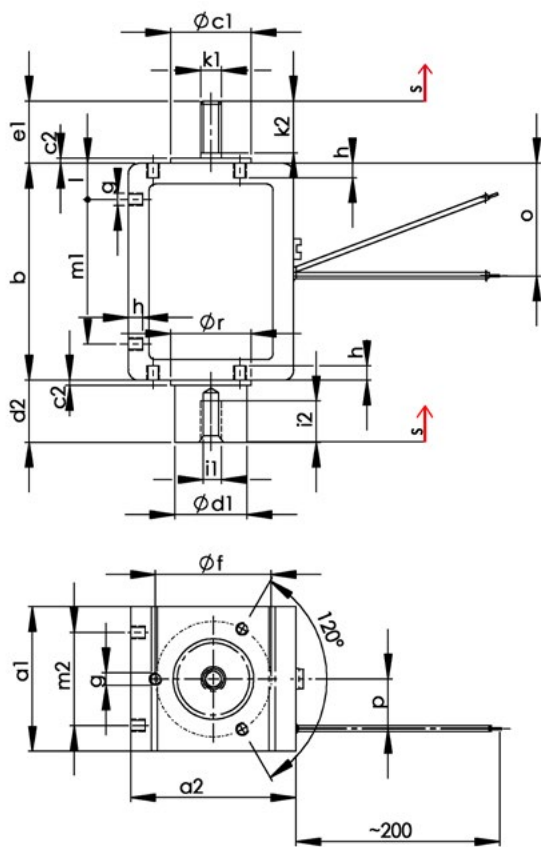

Armature position shown in currentless condition

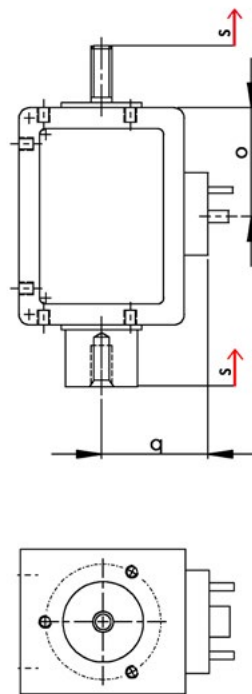

LCL-D with bellow

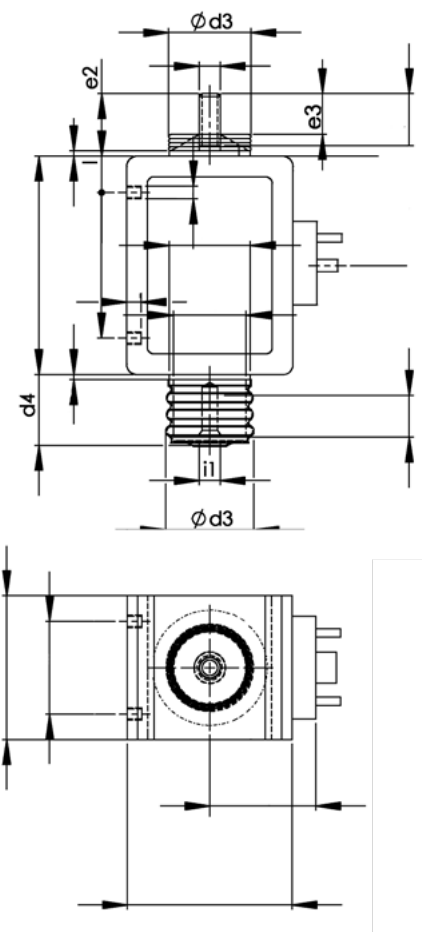

Dimensions in mm

Designation	s	a1	a2	b	c1	c2	d1	d2	*d3	*d4	e1	*e2	*e3	f	g	h	i1	i2	k1	k2	l	m1	m2	o	p	q	r
LCL030035	5	30	35	45	17	2.5	15	8	26.5	14	25	29	10	24	M3	3.5	M4	8	M4	10	10	25	22	22.5	9	27	17
* with bellow	10							13		19	20	24															
	15							18		24	15	19															
LCL040050	5	40	50	65	23	2.5	20	8	34	19	35	42	17	34	M4	5	M6	14	M6	15	12.5	40	30	32.5	9	34.5	23
*with bellow	10							13		24	30	37															
	15							18		29	25	32															
	20							23		34	20	27															
LCL048060	5	48	60	75	28	2.5	25	8	40	18	45	56	20	40	M4	6	M8	15	M8	20	15	45	38	37.5	9	39.5	28
*with bellow	10							13		23	40	51															
	15							18		28	35	46															
	25							28		38	25	36															
LCL060070	5	60	70	90	34	2.5	30	8	46	27	45	62	20	48	M5	6.5	M8	15	M8	20	15	60	48	45	9	44.5	34
*with bellow	10							13		32	40	57															
	15							18		37	35	52															
	25							28		47	25	42															
LCL070080	5	70	80	105	39	2.5	35	8	53	30	55	75	25	56	M6	7	M10	22	M10	25	17.5	70	55	52.5	9	49.5	39
*with bellow	10							13		35	50	70															
	15							18		40	45	65															
	20							23		45	40	60															
	30							33		55	30	50															

LCL030035

Duty cycle [%]	100			40			25			5		
Stroke [mm]	5	10	15	5	10	15	5	10	15	5	10	15
Response time [ms]	61	68	75	53	59	65	41	45	50	24	27	30
Release time [ms]	28	32	35	24	27	30	20	23	25	16	18	20
Rated power [W]	10.5			18			26.5			100		
Armature weight [kg] *	0.055 (0.06)			0.055 (0.06)			0.055 (0.06)			0.055 (0.06)		
Solenoid weight [kg] *	0.25 (0.3)			0.25 (0.3)			0.25 (0.3)			0.25 (0.3)		
Insulation class	B			B			B			B		

* Value in brackets: (LCL with bellow)

✔ Standard devices (Page 4)

LCL030035 (43 11...03D00/D50)

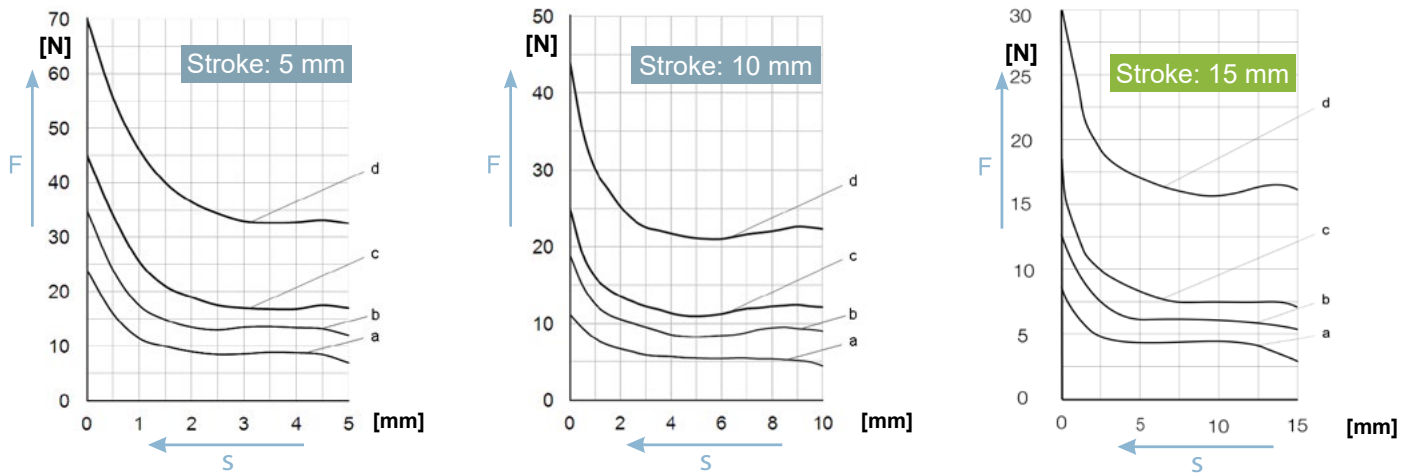

LCL040050

Duty cycle [%]	100				40				25				5			
Stroke [mm]	5	10	15	20	5	10	15	20	5	10	15	20	5	10	15	20
Response time [ms]	98	109	122	135	66	73	81	90	51	57	63	70	33	36	41	45
Release time [ms]	33	36	41	45	29	32	36	40	24	27	30	33	18	20	23	25
Rated power [W]	18				38				57				234			
Armature weight [kg] *	0.125 (0.15)				0.125 (0.15)				0.125 (0.15)				0.125 (0.15)			
Solenoid weight [kg] *	0.66 (0.79)				0.66 (0.79)				0.66 (0.79)				0.66 (0.79)			
Insulation class	B				B				B				B			

* Value in brackets: (LCL with bellow)

✔ Standard devices (Page 4)

LCL040050 (43 11...04E00/E50)

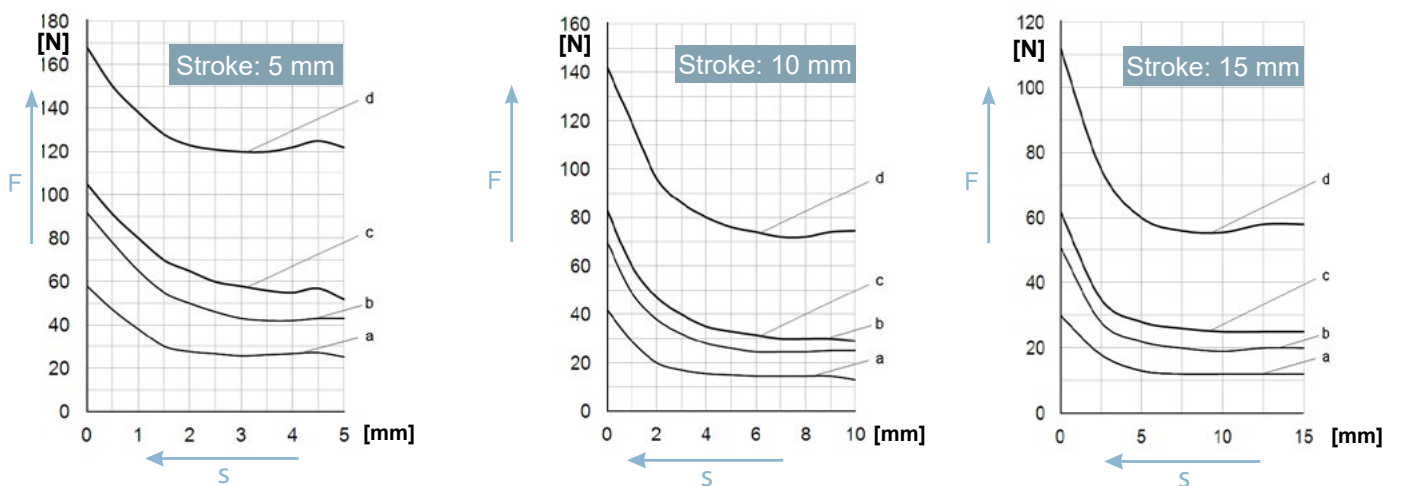

Other voltages and duty cycles are available on request
 +49 771 8009 3770 or sales-ims@kendrion.com

Stroke Force Curves

Values in brackets = old designation

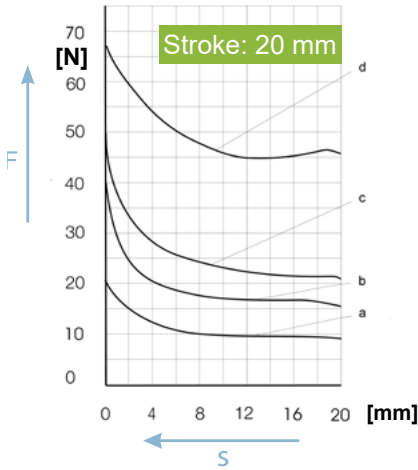

The power indicated is reached at 90% of the rated voltage. The solenoids can be installed in any position, but the force transfer should be in axial direction only. The values for the duty cycles are reference values and apply for rated voltage, warmed-up condition and load with 70% of the magnetic force of the device.

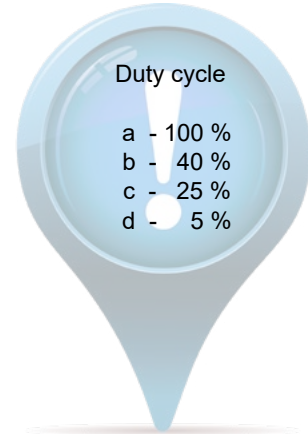

LCL048060

Duty cycle [%]	100				40				25				5			
Stroke [mm]	5	10	15	25	5	10	15	25	5	10	15	25	5	10	15	25
Response time [ms]	144	160	178	220	92	102	113	140	62	69	77	95	33	37	41	50
Release time [ms]	36	40	45	55	33	36	40	50	26	29	32	40	20	22	24	30
Rated power [W]	22				45				75				308			
Armature weight [kg] *	0.23 (0.26)				0.23 (0.26)				0.23 (0.26)				0.23 (0.26)			
Solenoid weight [kg] *	1.16 (1.28)				1.16 (1.28)				1.16 (1.28)				1.16 (1.28)			
Insulation class	B				B				B				B			

* Value in brackets: (LCL with bellow)



LCL048060 (43 11...05D00/D50)

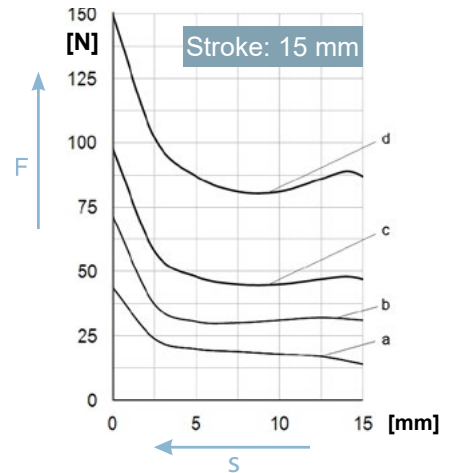
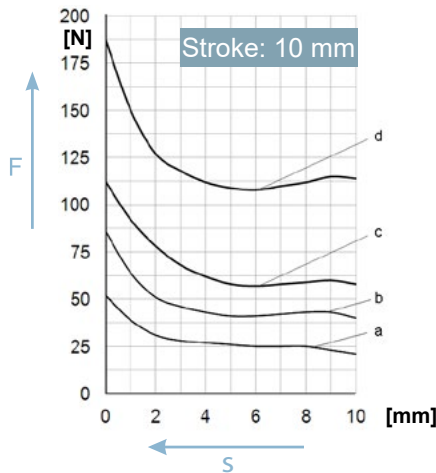
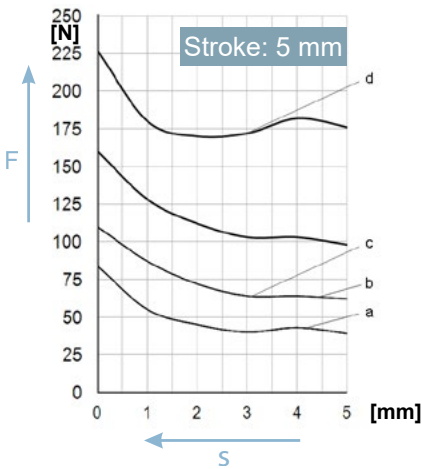

Stroke Force Curves

Values in brackets = old designation

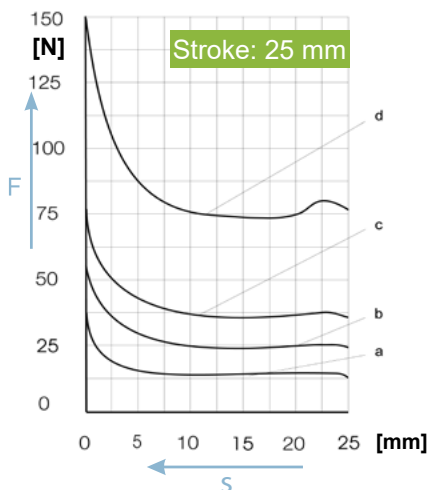

The power indicated is reached at 90% of the rated voltage. The solenoids can be installed in any position, but the force transfer should be in axial direction only. The values for the duty cycles are reference values and apply for rated voltage, warmed-up condition and load with 70% of the magnetic force of the device.

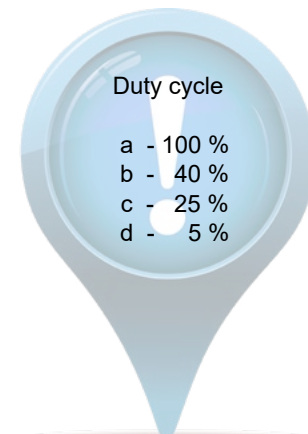

LCL060070

Duty cycle [%]	100				40				25				5			
Stroke [mm]	5	10	15	25	5	10	15	25	5	10	15	25	5	10	15	25
Response time [ms]	230	255	284	350	138	153	170	210	86	95	105	130	36	40	45	55
Release time [ms]	44	49	54	67	41	45	50	62	31	35	39	48	24	26	29	36
Rated power [W]	28				65				98				470			
Armature weight [kg] *	0.41 (0.50)				0.41 (0.50)				0.41 (0.50)				0.41 (0.50)			
Solenoid weight [kg] *	2.04 (2.50)				2.04 (2.50)				2.04 (2.50)				2.04 (2.50)			
Insulation class	B				B				B				B			

* Value in brackets: (LCL with bellow) ✔ Standard devices (Page 4)

LCL060070 (43 11...06D00/D50)

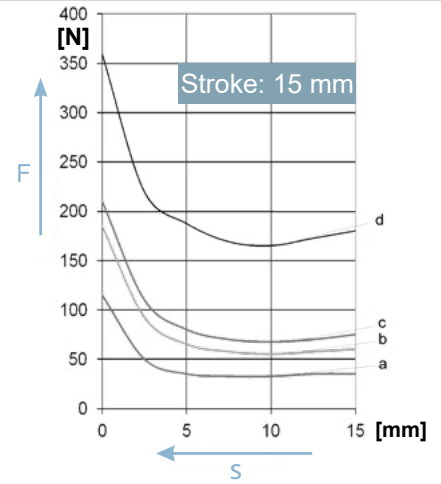
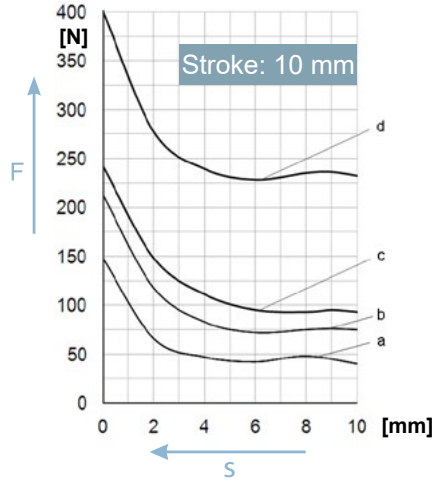
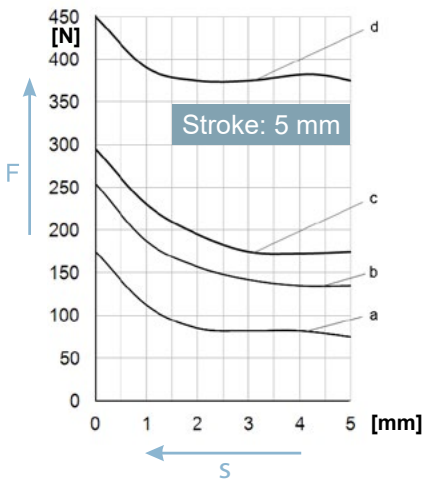

Stroke Force Curves

The power indicated is reached at 90% of the rated voltage. The solenoids can be installed in any position, but the force transfer should be in axial direction only. The values for the duty cycles are reference values and apply for rated voltage, warmed-up condition and load with 70% of the magnetic force of the device.

Values in brackets = old designation

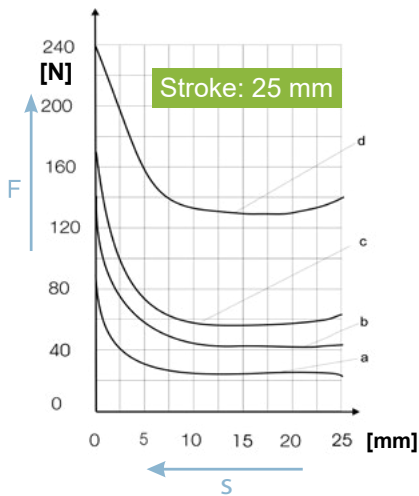
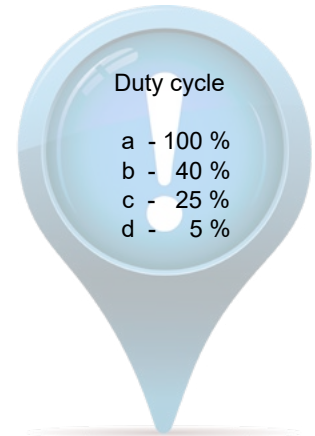

Other voltages and duty cycles are available on request
+49 771 8009 3770 or sales-ims@kendrion.com

LCL070080

Duty cycle [%]	100					40					25					5				
Stroke [mm]	5	10	15	20	30	5	10	15	20	30	5	10	15	20	30	5	10	15	20	30
Response time [ms]	266	295	328	365	450	186	207	230	255	315	103	115	128	142	175	35	39	44	49	60
Release time [ms]	48	53	59	66	81	47	52	58	65	80	34	38	42	47	58	25	28	31	35	43
Rated power [W]	39					95					150					680				
Armature weight [kg] *	0.63 (0.77)					0.63 (0.77)					0.63 (0.77)					0.63 (0.77)				
Solenoid weight [kg] *	3.25 (3.40)					3.25 (3.40)					3.25 (3.40)					3.25 (3.40)				
Insulation class	B					B					B					B				

* Value in brackets: (LCL with bellow) ✔ Standard devices (Page 4)

LCL070080 (43 11...07D00/D50)

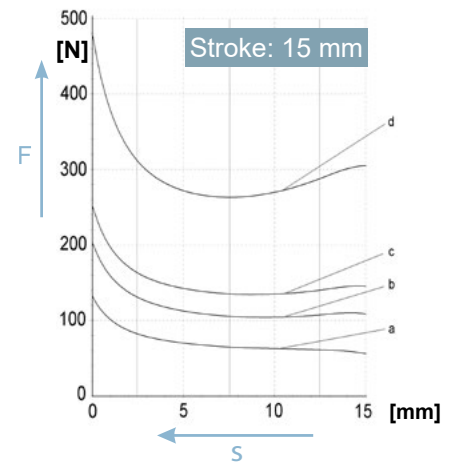
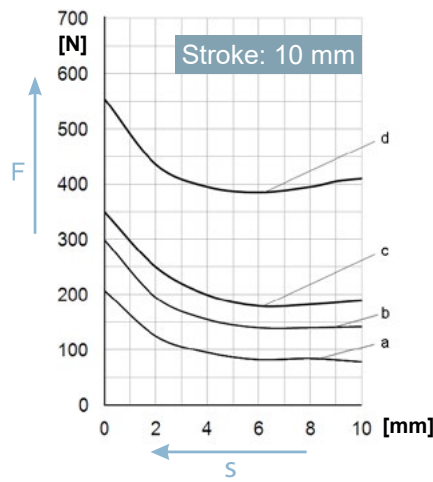
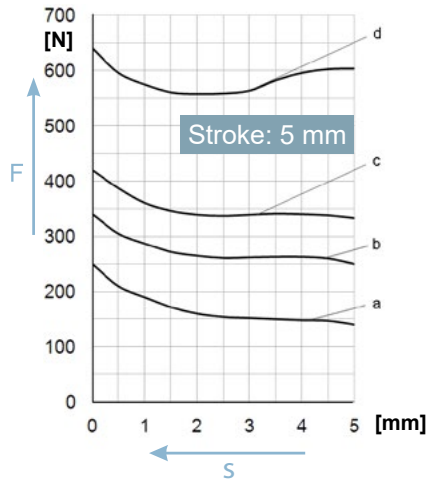

Stroke Force Curves

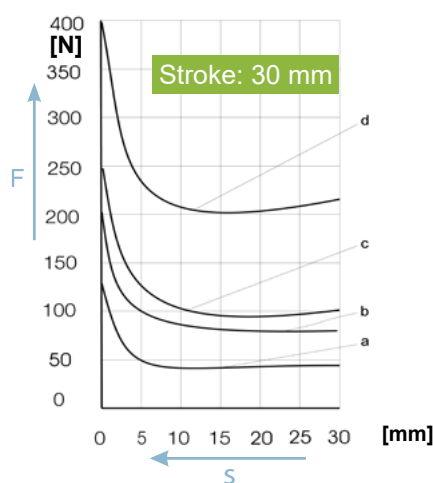
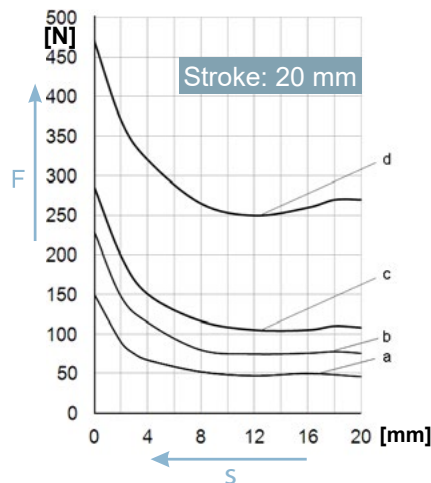

The power indicated is reached at 90% of the rated voltage. The solenoids can be installed in any position, but the force transfer should be in axial direction only. The values for the duty cycles are reference values and apply for rated voltage, warmed-up condition and load with 70% of the magnetic force of the device.

Values in brackets = old designation



Other voltages and duty cycles are available on request
+49 771 8009 3770 or sales-ims@kendrion.com

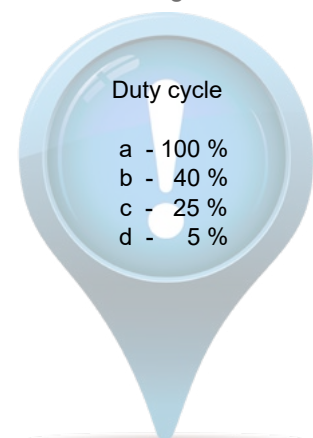

Spring Set

A spring is clamped at the armature by means of a screw and a disc. As the spring is mounted to the outside of the solenoid this accessory cannot be mounted to the models IP54 with bellow.

The assembly is very easy, only an Allen key is required. The spring set can be used in combination with the LCL standard.

Installation Note

Magnetic force is reduced by spring force.



Cross section

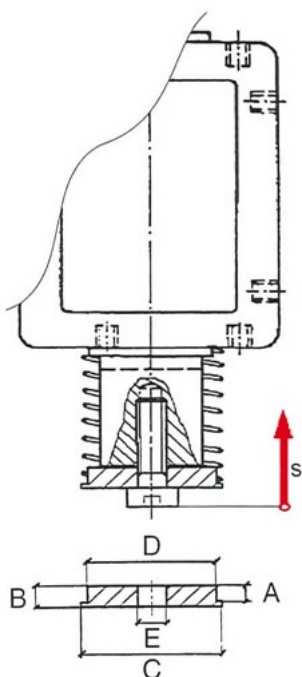

Technical Data

Reset spring set for type	A [mm]	B [mm]	C [mm]	D [mm]	E [mm]
LCL030035	4	9	19	17	4.2
LCL040050	8.5	10.5	26	23	6.2
LCL048060	9	12	31	28	8.2
LCL060070	13	16	37.5	34	8.2
LCL070080	18	22	42.5	39	10.2

Technical Data

	LCL030035			LCL040050				LCL048060			
Stroke [mm]	5	10	15	5	10	15	20	5	10	15	25
Spring force F [N]											
Initial force	2.3	1.7	1.1	5.5	4.5	3.5	2.5	9.0	7.9	6.8	4.7

	LCL060070				LCL070080				
Stroke [mm]	5	10	15	25	5	10	15	20	30
Spring force F [N]									
Initial force	10.7	9.6	8.4	7.3	16.8	15.5	14.2	13	10.5

Plug-in connector acc. DIN EN 175301-803 with / without bridge rectifier depending on the voltage

The 2-pole plug-in connector with protective lead is a connection specially designed for electro-magnetic devices.

The cable outlet can be rotated 4 x 90° by inserting the contact carrier accordingly.

After attaching the plug-in connector to the pin plate of the device plus sealing it is secured with a machine screw supplied. This guarantees an exact seal of the combination and prevents the plug-in connector from being accidentally detached under vibration.

A cable gland Pg 11 (material no. 430006) serves to seal the cable. The contact elements are suitable for connecting-wire cross sections of up to 1.5 mm². Air clearance and leakage paths acc. VDE 0110.

Model

- Type 430006 without integrated bridge rectifier
- Type 430001 with integrated bridge rectifier



Technical Data

- Insulation class C
- Protection class IP 65 (in plugged in and secured condition)
- Plug load 2.5 A

Dimension Drawing (Plug-in connector design A)

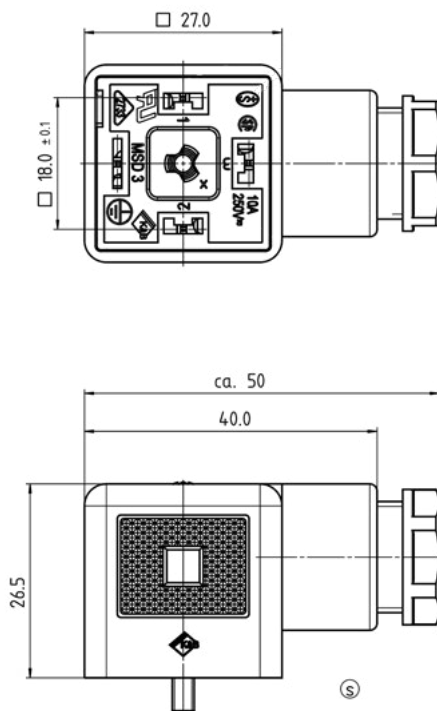

Fork head acc. DIN 71752

Fork heads are used to connect all types of linear solenoids to force transfer elements such levers, push bars, valve flaps and sliding dampers. In many cases they enable rapid connection during assembly and also quick replacement of wear and spare parts.

The types without ES-bolt achieve the force transfer between fork head and customer application by a cylindrical pin with common safety elements.

The fork heads are electrogalvanised.

Installation Note

With its thread the fork head is screwed to the pull or push bar of the linear solenoid and secured with a locknut.



Dimension Drawing

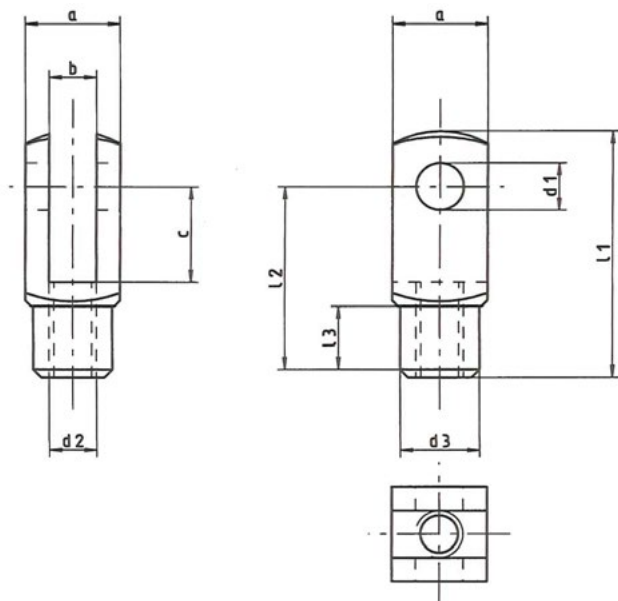

Technical Data

Designation	a	b	c	d1	d2	d3	i1	i2	i3
GK 1	8	4	8	4	M4	8	21	16	6
GK 2	10	5	10	5	M5	9	26	20	8
GK 3	12	6	12	6	M6	10	31	24	9
GK 4	16	8	16	8	M8	14	42	32	12
GK 5	20	10	20	10	M10	18	52	40	15
GK 6	24	12	24	12	M12	20	62	48	18

Snap-on fork pins acc. 71752

The use of a fork head with snap-on fork pin results in a quickly assembled and readily detachable connection (no tools required) between the linear solenoid and the component.

The spring clip ensures that the fork pin remains securely in position. The fork heads are electrogalvanised, the fork pins are electrogalvanised.



Technical Explanations

Thermal Classes

As shown in the table below thermal classes are classified according to DIN VDE 0580 / 07.2000 into insulation classes on the basis of their longterm thermal stability. Depending on the type our linear solenoids are manufactured in thermal classes E, B and F. If required by the application most devices can also be delivered in thermal class H.

Thermal class	Limit temperature °C	Limit overtemperature °C
Y	90	50
A	105	65
E	120	80
B	130	90
F	155	115
H	180	140

Protection Classes [IP]

Protection classes are indicated by a short symbol consisting of the two invariable code letters IP and two code letters for the degree of protection. The protection classes indicated are determined according to IEC 60529. They apply to protection against contact and against penetration of foreign substances. The second code letter applies to protection against penetration of water.

In case the protection class of e.g. the electrical connection deviates from that of the solenoid the protection class of the connection is indicated separately, e.g. housing IP 54, connection IP 00.

Code Letters Protection against contact and foreign substances	
0	no protection
1	protection against big foreign substances
2	protection against medium-sized foreign substances
3	protection against small foreign substances
4	protection against grain-shaped foreign substances
5	protection against dust deposit
6	protection against dust penetration

Code Letters Protection against water	
0	no protection
1	protection against vertical dripping water
2	protection against dripping water falling at an angle
3	protection against spray water
4	protection against splashing water
5	protection against flooding
6	protection against flooding
7	protection against immersion
8	protection against submersion

Rated Modes of Operation

Continuous operation is the operation during which the duty cycle is so long that the SteadyState temperature is reached.

Intermittent operation is the operation during which duty-cycle and currentless break alternate in regular and irregular intervals, the breaks being so short that the device cannot cool down to the reference temperature.

Short time operation is the operation during which the duty cycle is so short that the SteadyState time is not reached. The currentless break is so long that the solenoid cools down to the reference temperature.

Technical Terms Related to Electricity

The rated voltage (U_N) is the voltage with which the solenoid is operated in normal operation.

The rated power (P_N) is the power which results from the rated voltage and the rated current with DC solenoids of a coil temperature of 20°C.

The rated current (I_N) is the current which results from the rated voltage (U_N) and the resistance (R20) with a coil temperature of 20°C.

Technical Terms Related to Force

Magnetic force is the exploitable mechanical force reduced by the friction which is generated in stroke direction. The magnetic force is safely reached with 90% rated voltage and maximum warming. With rated voltage the listed values rise by approx. 20%.

Stroke force is the magnetic force which acts outside taking the respective component of armature weight into consideration.

Holding force is the magnetic force in stroke end position with DC-solenoids; with AC-solenoids it is the average value of the magnetic force periodically fluctuating with the alternating current in stroke end position.

Reset force is the force required to reset the armature into stroke start position after switching off the excitation current.

Relative duty cycle (% ED) is the ratio between duty cycle and cycle time in per cent. It is calculate according to the following formula:

$$\% ED = (\text{duty cycle} / \text{cycle time}) * 100$$

In order to calculate the relative duty cycle the preferred value of the cycle time acc. DIN VDE 0580 item 3.2.2 of 5 minutes is usually taken as a basis.

If the cycle time is irregular the relative duty cycle is determined from the ratio between the sum of the duty cycles and the sum of the cycle times over a longer period of operation.

The maximum values of the duty cycle must not be exceeded. If the relative duty cycle was determined and its value exceeds the permitted maximum value acc. DIN VDE the higher %-ED has to be selected into the range of which the duty cycle fits in. (Tables 1 and 2)

Cycle time is the sum of the duty cycle and the currentless break. For DC-solenoids the cycle time is max. 5 minutes = 300s. This equals 12 switches per hour. The minimum cycle time is limited by the response and release times in connection with the relative duty cycle. For a cycle time of 300s there are maximum values for the duty cycle which must not be exceeded. In case the permitted duty cycle is exceeded a solenoid of the next higher relative duty cycle has to be selected.

If the duty cycle of 180s is exceeded the solenoid has to be selected for 100% ED (continuous energisation) or in special cases of the duty cycle calculated from the off/on ratio needs to be adapted by proper selection of the magnetic coil.

If the cycle time is irregular the relative duty cycle is determined from the ratio between the added duty cycles and the added cycle times over a longer period of operation.

Under playing sequence we understand a single or periodically returning sequence of values for cycle time.

Relative duty cycle (% ED)	5	15	25	40	60	100
Permitted maximum duty cycle (s)	15	45	75	120	180	random

Table 1

Switching number (S / h)	12		120		300		600		1200		3000	
	300		30		12		6		3		1.2	
Cycle time (s)	300		30		12		6		3		1.2	
% ED	t _{on}	t _{off}	t _{on}	t _{off}	t _{on}	t _{off}	t _{on}	t _{off}	t _{on}	t _{off}	t _{on}	t _{off}
5	15	285	1.5	28.5	0.6	11.4	0.3	5.7	0.15	2.85	0.06	1.14
15	45	255	4.5	25.5	1.8	10.2	0.9	5.1	0.45	2.55	0.18	1.02
40	120	180	12.0	18.0	4.8	7.2	2.4	3.6	1.20	1.80	0.48	0.72
60	180	120	18.0	12.0	7.2	4.8	3.6	2.4	1.80	1.20	0.72	0.48
100	random											

Table 2



WE MAGNETISE THE WORLD

If you do not find what you are looking for, please feel free to contact us!
We will find the best solution for you.

Germany : Headquarters

Kendrion (Donaueschingen/Engelswies) GmbH
August-Fischbach-Straße 1
78166 Donaueschingen
Telefon: +49 771 8009 0
Telefax: +49 771 8009 3634
sales-ims@kendrion.com

Germany: Headquarters

Kendrion (Donaueschingen/Engelswies) GmbH
Hauptstraße 6
72514 Inzigkofen-Engelswies
Telefon: +49 7575 208 0
Telefax: +49 7575 208 3190
sales-ims@kendrion.com

For further contacts please refer to www.kendrion.com